



DxH 560 AL

» Small and Mighty

The compact 5-part differential autoload hematology analyzer for the low- to mid-volume, laboratory

 **Sanilabo**
Sanitaria de laboratorio

 **BECKMAN
COULTER**

DxH 560 AL HEMATOLOGY ANALYZER

High-quality results, even for patients with smaller samples.



THE NEW COMPACT AUTOLOADER BECAUSE GOOD THINGS COME IN SMALL PACKAGES

Spend more time on patient care and less on manual tasks with the powerful, compact DxH 560 AL, the latest addition to a family of solutions for busy clinics. With the DxH 560 autoloader system, laboratories can deliver critical first results accurately, with an **aspiration of only 17 µL**.

Experience **safety without compromise** with continuous load and walkaway capabilities. The DxH 560 AL analyzer provides users optimal safety against exposure to blood-borne pathogens with closed tube aspiration.

Easily load up to 50 samples without the need to stop analysis, up to 2x higher capacity than the closest competitor. Laboratories can also choose the open tube mode for even smaller draws and non-cap-pierceable collection tubes. Standardization for tube management is simplified with rule-driven testing.

THE DXH 560 AL ENABLES LABORATORIES TO:



**MAXIMIZE LABORATORY
PRODUCTIVITY**



**DELIVER SECURE,
HIGH-QUALITY RESULTS**



**IMPROVE
PHYSICIAN AND PATIENT
SATISFACTION**



FAMILY OF RELIABLE INSTRUMENTS

<1

SERVICE CALLS PER YEAR*

Save time and resources with the DxH 560 AL—a multi-tube, compact hematology analyzer with proven reliability, paperless data management and autonomous instrument tasks, meeting the increasing demands of secure data management.

Count on the DxH 560 AL to be available when you need it. With automated daily tasks, this instrument comes from a family of reliable instruments.

- > **Avoid system delays** with autonomous, pre-programmed daily maintenance and startup without the need for daily bleaching or manual intervention
- > **Store and manage with only two reagents** for a CBC/Diff
- > **Load and walk away** with up to 50-sample continuous loading capacity without the need to stop analysis
- > **Perform any system operation** in three touches or less
- > **Eliminate manual intervention** with pre-programmable QC and patient sample auto-rerun
- > **Easily change reagent bottles** or new lots of QC. The included barcode scanner uploads lot number, shelf life and reagent change date; and user name and open vial stability.



Each reagent can be changed individually in less than two minutes.

Propel laboratory performance

Rapid analysis—in 60 seconds or less

Simplify work processes and allow rapid turnaround of test results with intuitive, easy-to-use software.

Test in tight spaces

The DxH 560 AL uses up to a third less counter space than other analyzers in its class. The compact design can create greater workflow efficiency with optimal instrument placement.

Execute any command in three touches or less

Easily train others to operate the system with the DxH 560 AL analyzer's intuitive software. Complete any system operation in three steps or less and access all major functions from any screen.

RAPID ANALYSIS IN

<60
SECONDS

PERFORM ANY
SYSTEM OPERATION

IN 3 TOUCHES
OR LESS

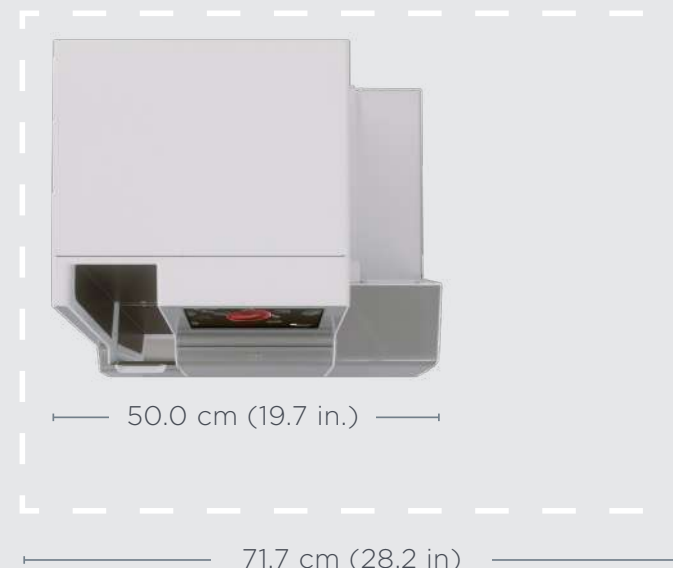

1/3 SMALLER FOOTPRINT

THAN THE CLOSEST COMPETITION*

Integrated screen and keyboard, only one external reagent, and compact footprint for flexible lab placement.

*DxH 500 and DxH 520 Oct 2020 year run report, >4,000 Global Placements

IMPROVE DATA AND QUALITY CONTROL MANAGEMENT

Gain powerful patient data-management tools

- › **Reduce cost and risk** associated with pre-analytical errors with a bidirectional host interface
- › **Expand sample data storage capacity**—up to 30,000 patient sample results, equivalent to up to a year's worth of tests with typical usage—for easy delta checks and file retrieval
- › **Download records quickly** and easily with a front-side USB connection port

Easily backup and restore patient test results, QC reports and consumable event logs

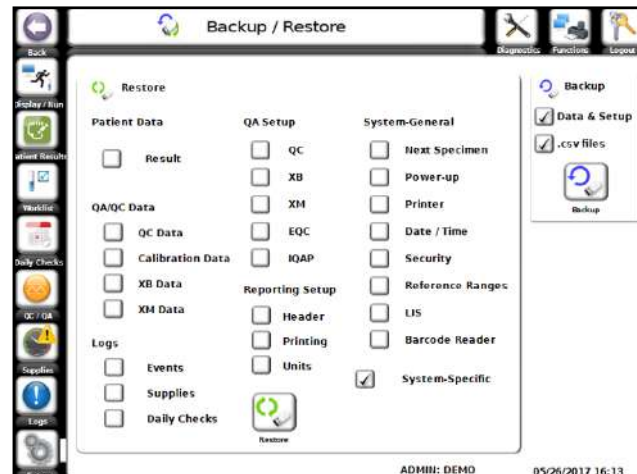

Preprogrammed daily and background checks

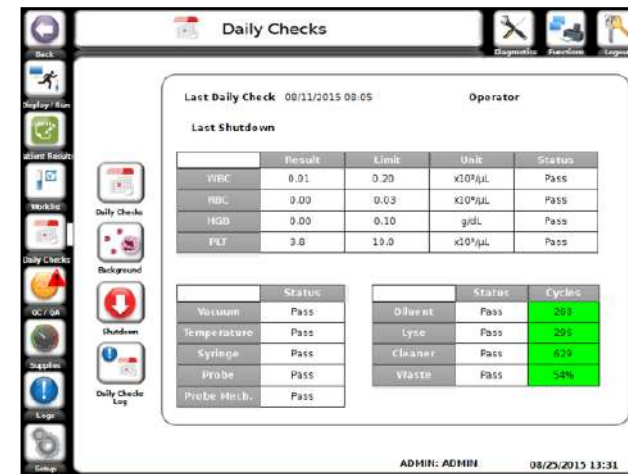

Deliver high-quality results

The DxH 560 AL system provides accurate results using Coulter Principle technology and flow cytometry with proprietary dynamic gating to achieve the white blood cell (WBC) differential. Cell counting and sizing is directly read with the Coulter Principle and is performed in duplicate for greater precision using the cyanide-free oxyhemoglobin methodology at 545 nm.

Patient result screen

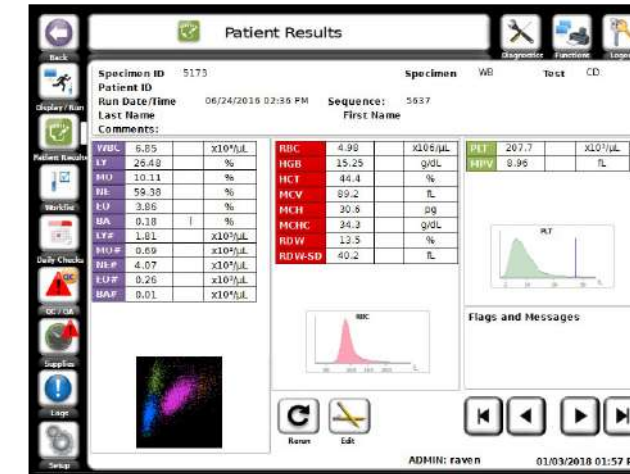

Easy-to-read QC charts

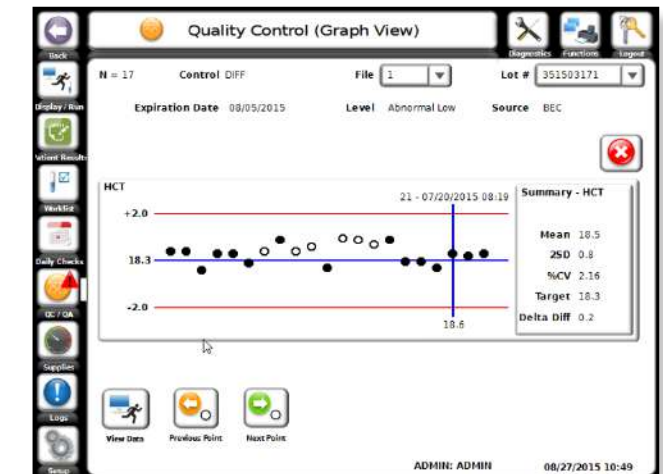

Achieve trusted performance with a robust QC management-tool package

- › **View Levey-Jennings limits** and quality control (QC) results with easy-to-interpret graphs
- › **Access online peer-group comparison** (IQAP) expertise and support
- › **Automate daily checks** and keep up to 50 data records stored for easy viewing
- › **Expand QC monitoring** with additional methodologies, such as XB and XM
- › **Monitor precision, bias and error** without an extra charge or the need for internet using on-board extended QC



IMPROVE FLAGGING WHILE MAINTAINING EFFECTIVE CLINICAL SENSITIVITY WHEN COMPARED TO STATIC-GATING

Apply flow cytometric optical analysis—Axial Light Loss (ALL)—and Coulter Principle innovation to WBC Differential Analysis

Combine ALL and Coulter Principle technologies to achieve an accurate leukocyte differential. The DxH 560 AL directly **analyzes all white blood cells** in an electro-optical flow cytometer module that uses a bright blue LED light source and DC (direct current). The digital information obtained from the WBC analysis is processed through the WBC differential algorithm.

The DxH 560 AL uses simultaneous measurements of volume and axial light loss within the WBC aperture to count and size **Lymphocytes, Monocytes, Neutrophils, Eosinophils and Basophils**. The LED in the optical assembly projects blue light through the aperture onto a sensor that detects axial light loss when passing cells interrupt the optical path. The amount of light falling on the sensor varies depending on cell structure. The DxH 560 algorithm generates the WBC differential, flagging and messaging.

Figure 1. A two-dimensional scatter plot is created with volume on the Y-axis and axial light loss on the X-axis (Figure 1.). WBC differential data is displayed in the diff plot. The WBC subpopulations are identified by color and intensity (concentration) within the diff plot.

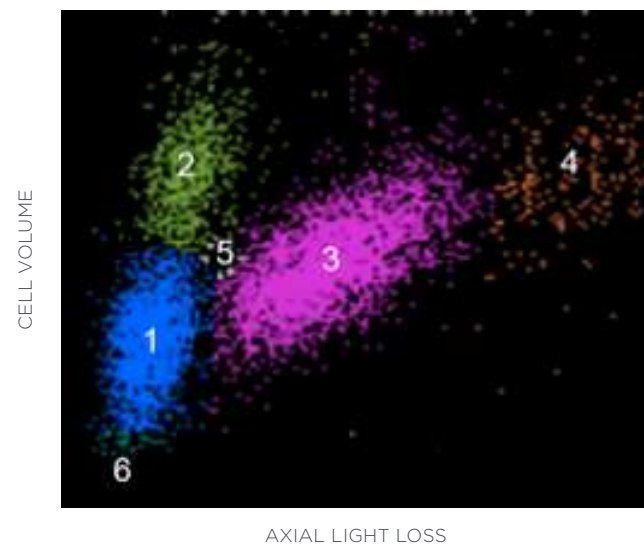

No.	WBC Subpopulation	Color
1	Lymphocyte	Blue
2	Monocyte	Green
3	Neutrophil	Purple
4	Eosinophil	Orange
5	Basophil	White

Reduce review (R) flagging while maintaining effective clinical sensitivity—with proprietary Dynamic-gating technology

The DxH 500 Series utilizes sophisticated Dynamic-gating technology improves the identification of leukocyte cell sub-populations by adjusting thresholds in real time between cell-cluster arrangements. With Beckman Coulter’s proprietary method, the gates move to more proper cutoffs between cell populations in a series of steps. Improved cutoffs, and subsequently better cell sub-typing are obtained, **reducing review (R) flags by 40%** in challenging cell populations, such as lymphocytes and eosinophils. This gives a more accurate leukocyte differential than static gating.

Achieve accurate CBC sizing and counting with digital pulse processing

Proprietary pulse processing enables the recognition of data points that fall outside the optimal counting zone. Recognizing these data points as outliers and subsequently removing the unreliable data points enhances cellcount accuracy (Figure 3.). Quality results are further improved with dual-count apertures and a wide linearity range for a more comprehensive patient-care capability.

Figure 3: Coulter digital pulse processing for counting and sizing

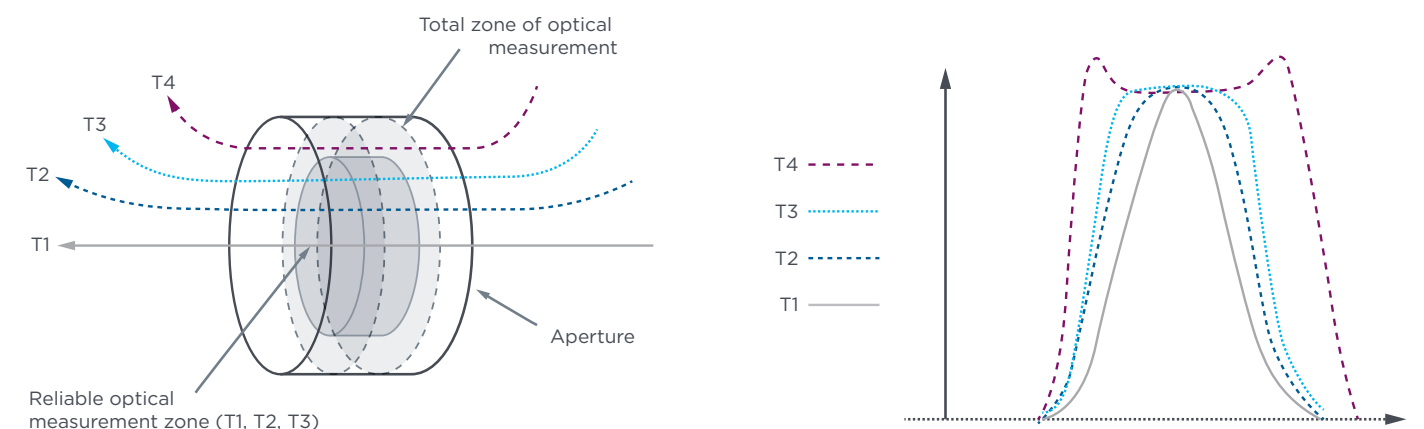

Figure 2a: Static-gating

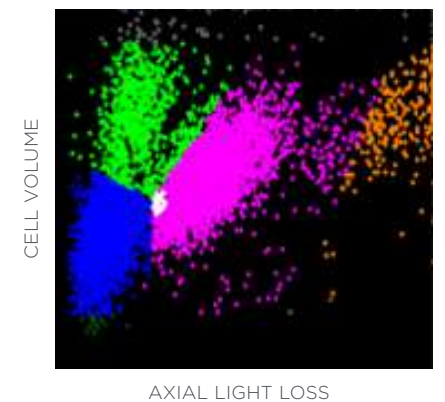
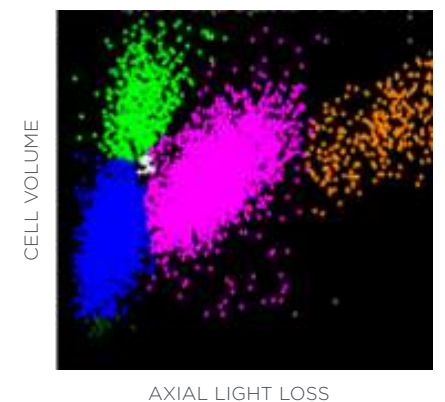

Figure 2b: Dynamic-gating



IMPROVE PHYSICIAN AND PATIENT SATISFACTION



Accurate results, even from low-volume specimens

Conserve precious samples from difficult-to-draw patients, such as infant and oncology patients. With the DxH 560 AL, laboratories can deliver critical first results accurately with an aspiration volume of only 17 μ L—less than a drop of blood.

Report pediatric results with confidence based on ranges established specifically for the DxH line—the first portfolio of hematology analyzers with established comprehensive age- and sex-specific reference ranges. Robust pediatric reference ranges assist in more accurate test result interpretation.*

Provide peace of mind for your patients with industry-leading privacy and security features—including customizable user login and fully traceable automated timeouts—guarding patient electronic personal health information.



*CALIPER Hematology Reference Standards (II): Improving Laboratory Test Interpretation in Children (Beckman Coulter DxH 520 – Physician Office Hematology System) with Analytical Comparison to Beckman Coulter DxH 900
Victoria Higgins (PhD)^{a,b,*}, Houman Tahmasebi (MSc)^{a,*}, Mary Kathryn Bohn (BSc)^{a,b}, Alexandra Hall (MPH)^a and Khosrow Adeli (PhD)^{a,b*}
*American Journal of Clinical Pathology, Volume 154, Issue 3, September 2020, Pages 342–352, <https://doi.org/10.1093/ajcp/aqaa057>
Published: 11 June 2020

DxH 560 AL Hematology Analyzer Specifications

Mode of Operation	Autoloader, 50 tube continuous feed capacity, Open-tube mode			
Sample Volume	17 μ L of venous or micro-collected whole blood			
Throughput	55 closed-tube samples per hour, 60 open-tube samples per hour			
Menu/Test Parameters	WBC, RBC, HGB, HCT, MCV, MCH, MCHC, RDW-SD, RDW-CV, PLT, MPV, LY%, LY#, MO%, MO#, NE%, NE#, EO%, EO#, BA%, BA# *			
Weight and Dimensions	WIDTH	HEIGHT	DEPTH	WEIGHT
	50.0 cm (19.7 in.)	44.0 cm (17.3 in.)	46.0 cm (18.1 in.)	22.0 kg (48.5 lbs.)



DxH 500 Open Tube



DxH 520 Closed Tube



DxH 560 Autoloader

Ordering Information	Part Number
DxH 560 AL Hematology Analyzer	B40603
DxH 500 Series Diluent (10 L each)	B36845
DxH 500 Series Lyse (500 mL each)	B36846

Ordering Information	Part Number
DxH 500 Series Cleaner (500 mL each)	B36868
DxH Series Calibrator (2 x 2.0 mL)	B36880
DxH 500 Series Control (6 x 2.3 mL, tri-level sets)	B36872



BECAUSE GREAT THINGS
COME IN **SMALL PACKAGES**

 **Sanilabo**
Sanitaria de laboratorio



SAVE TIME AND RESOURCES with a compact autoloading hematology analyzer that has proven analytical reliability, paperless data management and autonomous instrument daily cleaning.

DELIVER SECURE, HIGH-QUALITY, CONFIDENT RESULTS with fewer, slide reviews within secure and expanded patient database capability.

IMPROVE PHYSICIAN AND PATIENT SATISFACTION with reduced need for redraws, even for difficult-to-draw individuals such as infant, geriatric and oncology patients, without compromising on quality.

Enhance your laboratory operations and improve patient care with our hematology solutions. Visit www.beckmancoulter.com/hematology

References

1. Beckman Coulter. DxH 560 AL Instructions for Use.

 **BECKMAN
COULTER**